

BULB SHAPED
16." - 1/4
 (BY BULB DIA.)

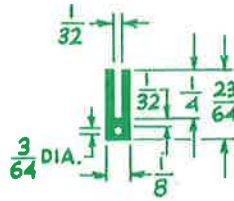

GR 205



GR 773

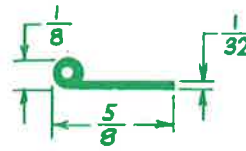

GR 418

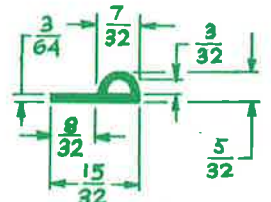

GR 210

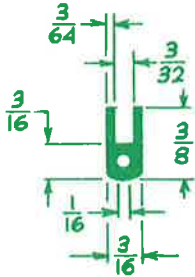

GR 777

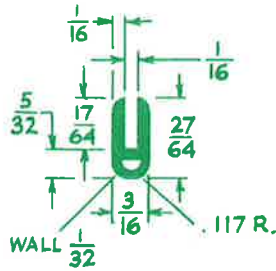

GR 348

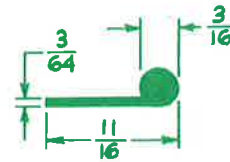

GR 788

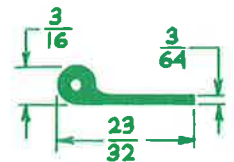

GR 617

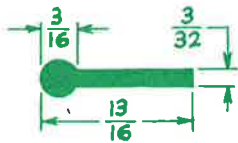

GR 789

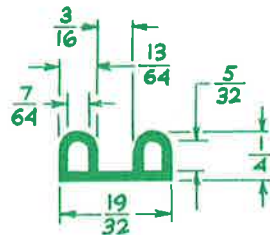

GR 698

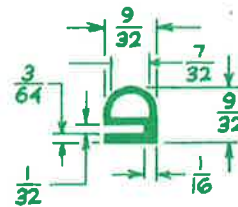

GR 778

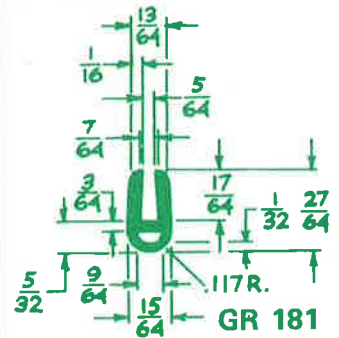

GR 181

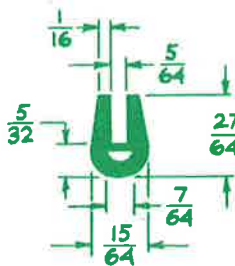

GR 674

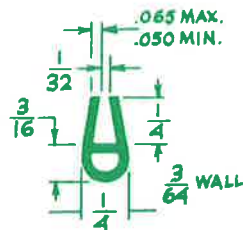

GR 407

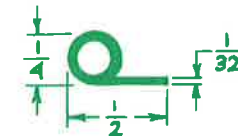

GR 679



GR 372

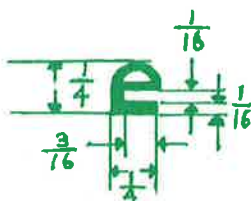

GR 1102

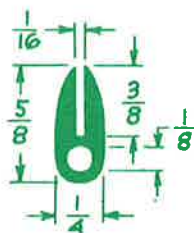

GR 775

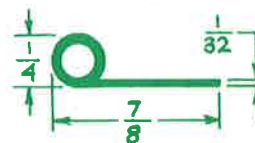



GR 728

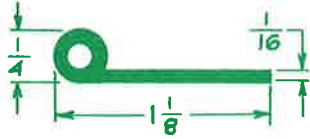
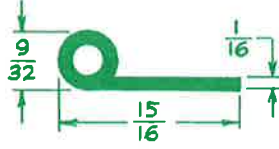
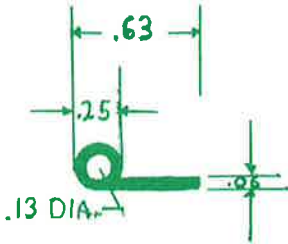
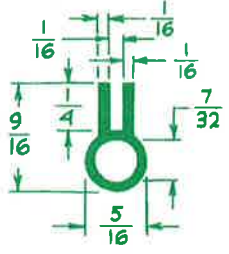
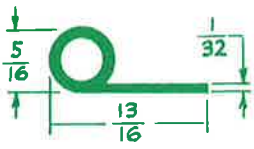
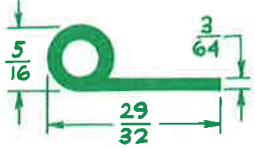
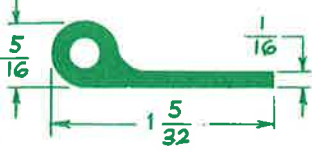
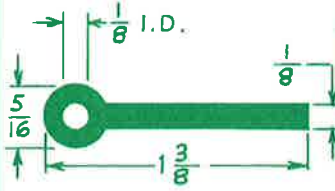
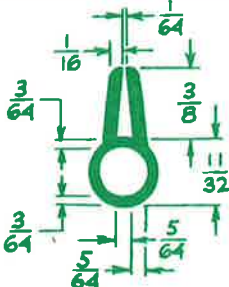
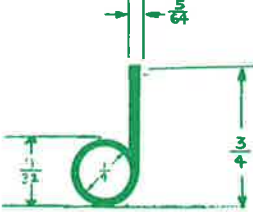
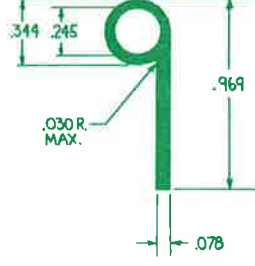
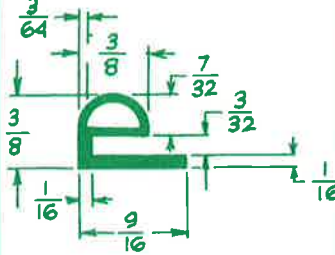
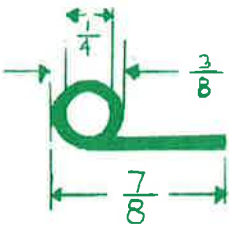

GR 417

Size will vary as color, durometer or compound changes.

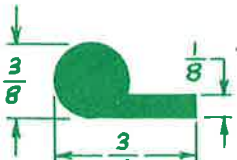
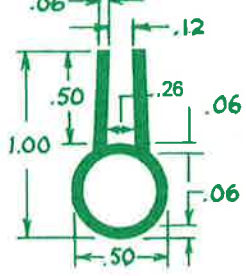
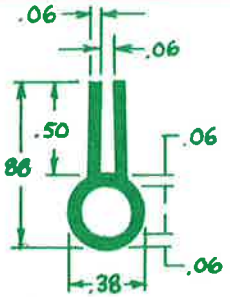
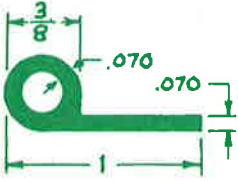
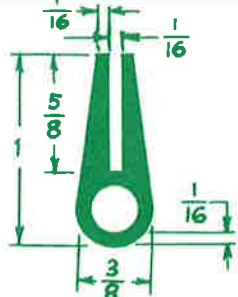
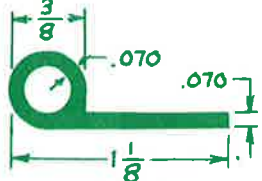
 <p>GR 729</p>	 <p>GR 730</p>	 <p>GR 848</p>	 <p>GR 774</p>
 <p>GR 731</p>	 <p>GR 732</p>	 <p>GR 733</p>	 <p>GR 720</p>
 <p>GR 180</p>	 <p>GR 490</p>	 <p>GR 817</p>	 <p>GR 780</p>
 <p>GR 831</p>	 <p>GR 734</p>	 <p>GR 197</p>	 <p>GR 342</p>
 <p>GR 427</p>	 <p>GR 306</p>	 <p>GR 776</p>	 <p>GR 314</p>

Size will vary as color, durometer or compound changes.

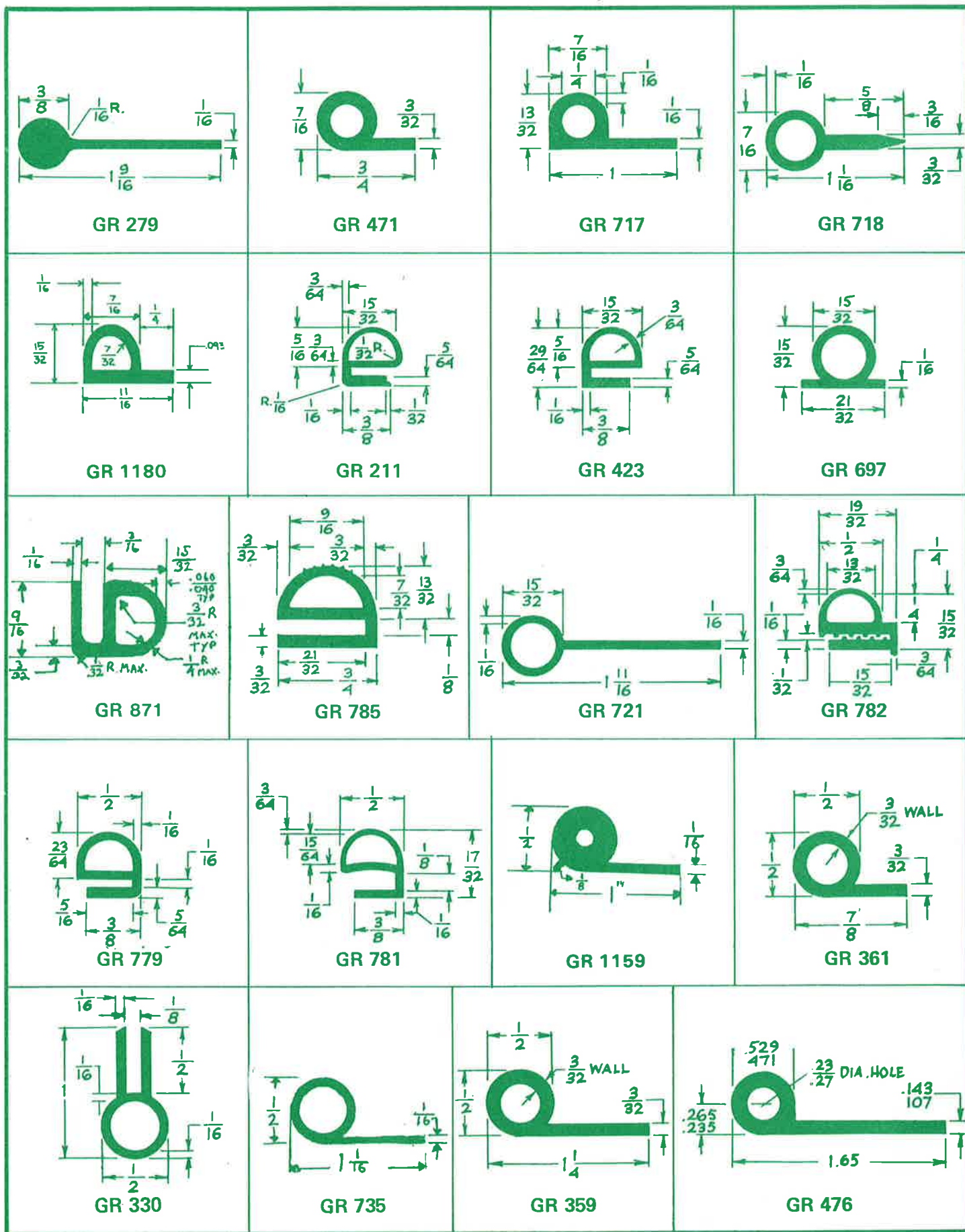

Size will vary as color, durometer or compound changes.

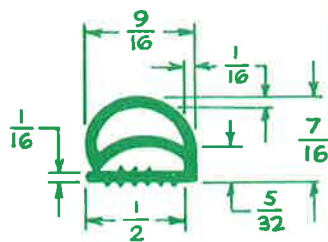

GR 783

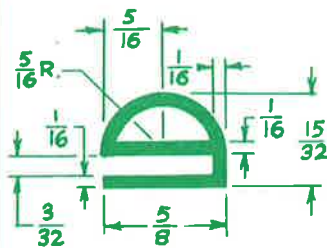

GR 175

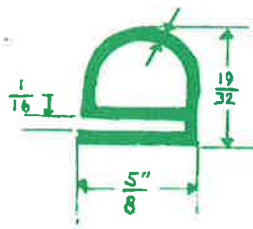

GR 1184

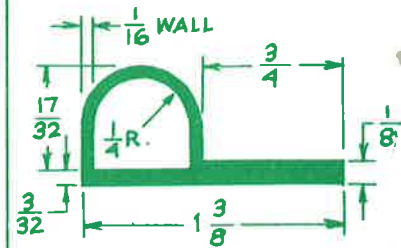

GR 187

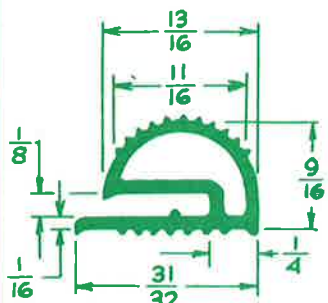

GR 784

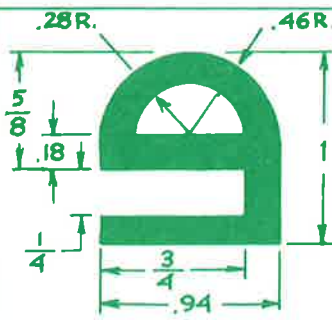

GR 453

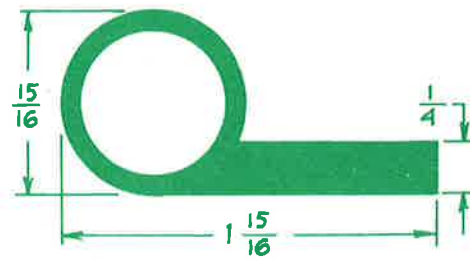

GR 737

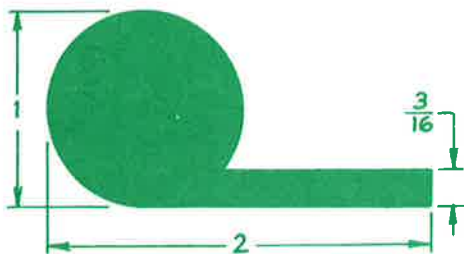

GR 738

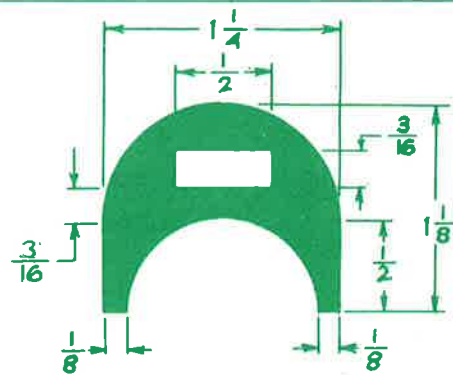

GR 118

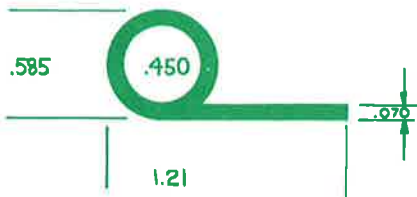

GR 1178

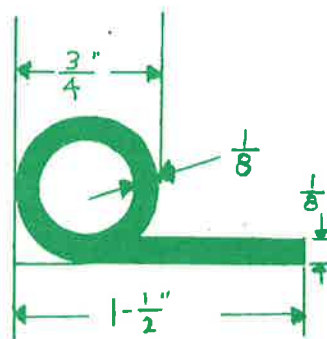

GR 1196