

GR 185

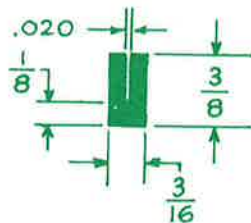

GR 186

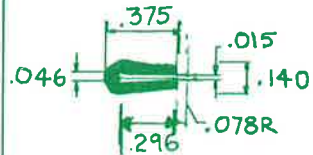

GR 874

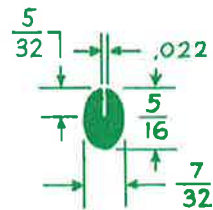

GR 190

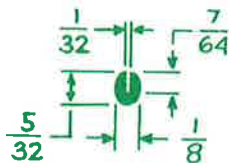

GR 616

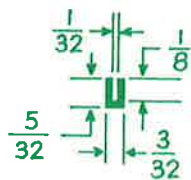

GR 615

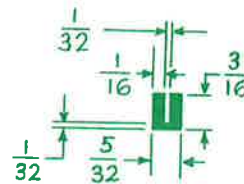

GR 500

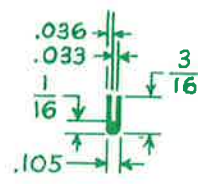

GR 312

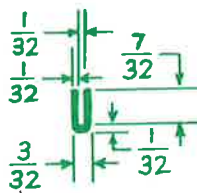

GR 213

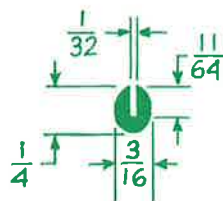

GR 618

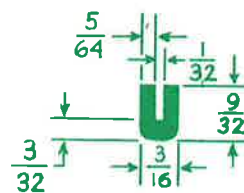

GR 501

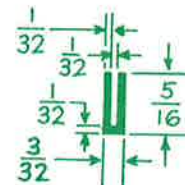

GR 502

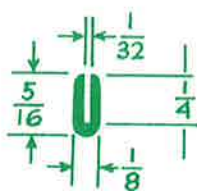

GR 619

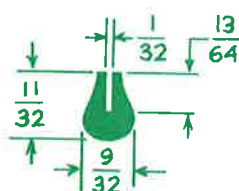

GR 620

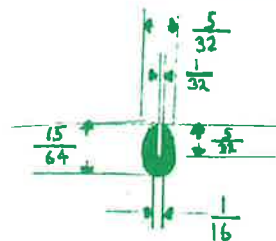

GR 875

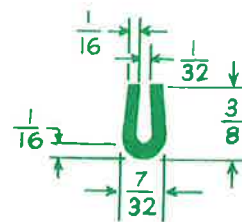

GR 504

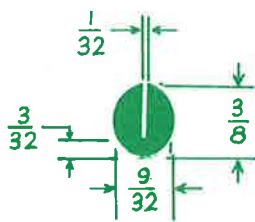

GR 505

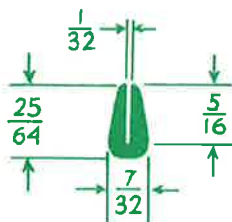

GR 621

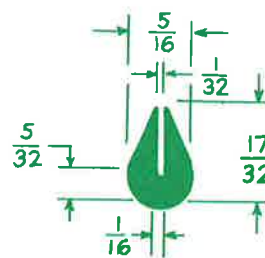

GR 506

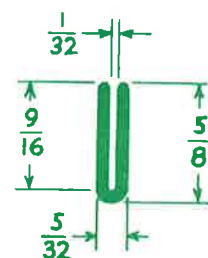

GR 622

Size will vary as color, durometer or compound changes.

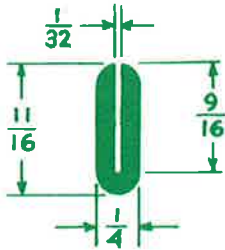

GR 623

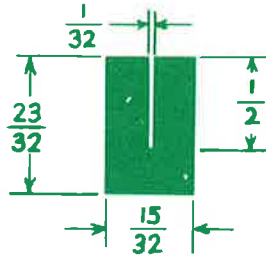

GR 624

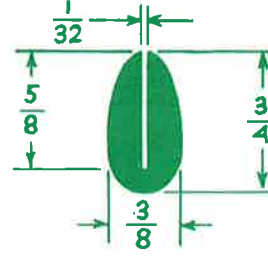

GR 625

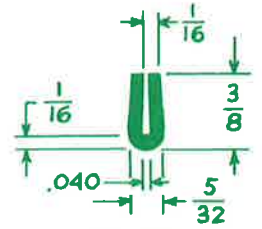

GR 507

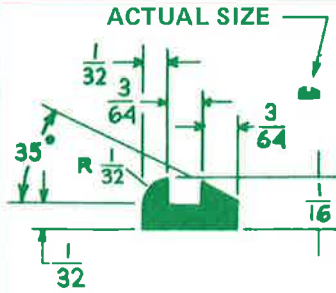

GR 129

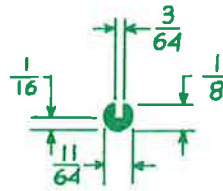

GR 508

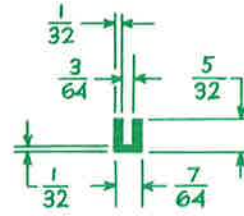

GR 430

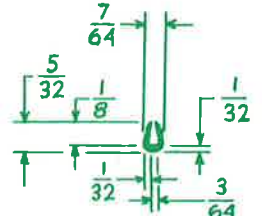

GR 445

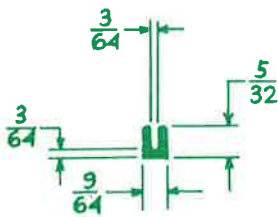

GR 626

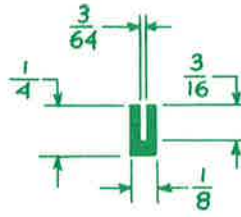

GR 627

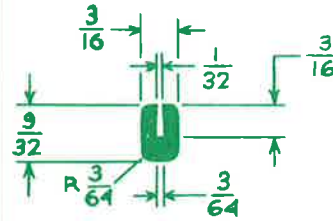

GR 443

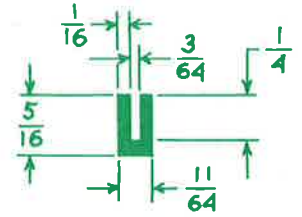

GR 254

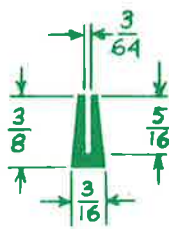

GR 628

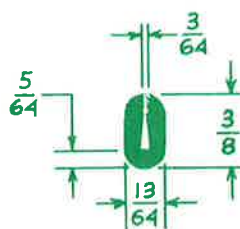

GR 121

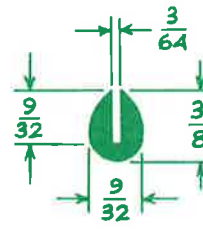

GR 130

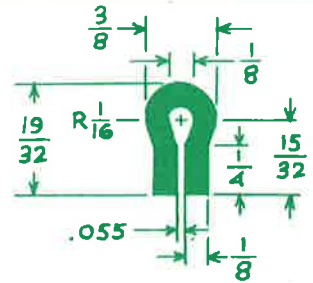

GR 465

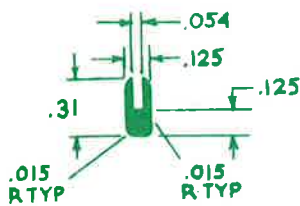

GR 371

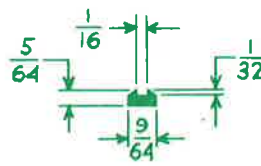

GR 629

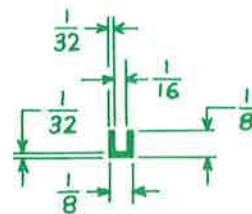

GR 290

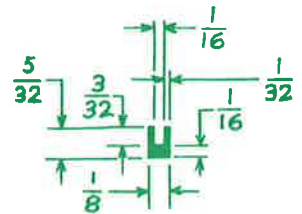

GR 275

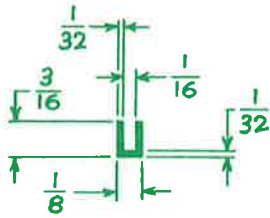

GR 509

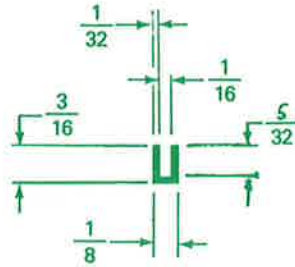

GR 261

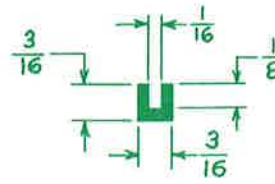

GR 630

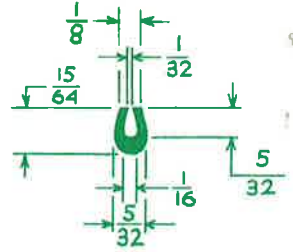

GR 232

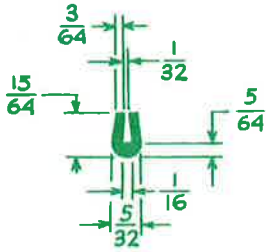

GR 246

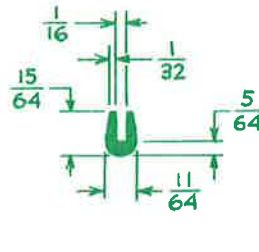

GR 631

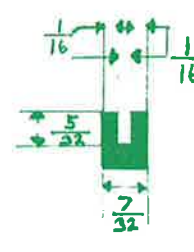

GR 857

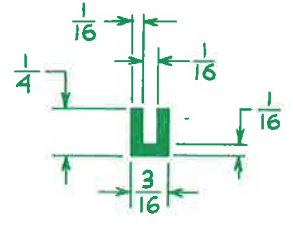

GR 510

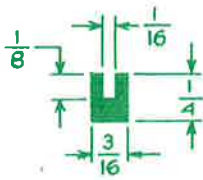

GR 633

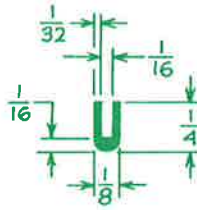

GR 511

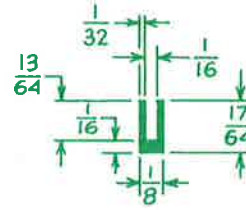

GR 231

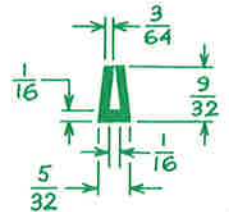

GR 512

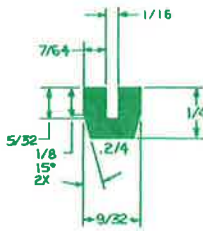

GR 1173

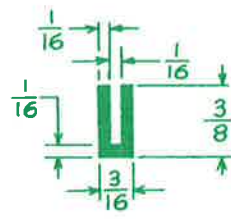

GR 221

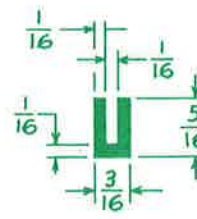

GR 116

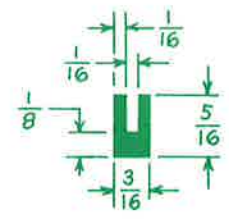

GR 636

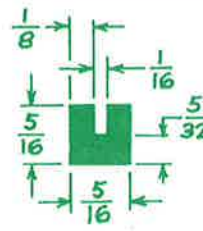

GR 460

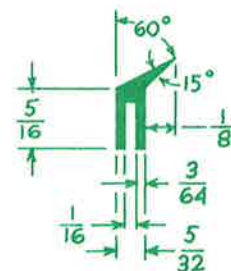

GR 302

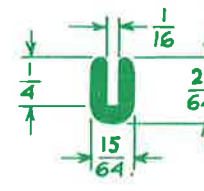

GR 635

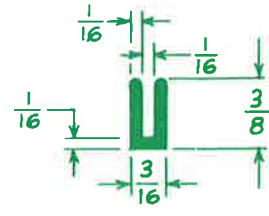

GR 514

Size will vary as color, durometer or compound changes.

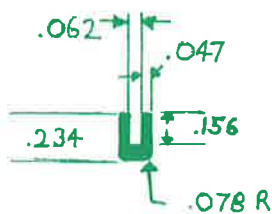

GR 1199

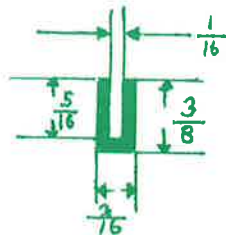

GR 1149

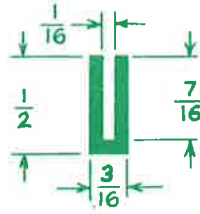

GR 638

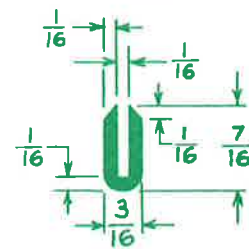

GR 517

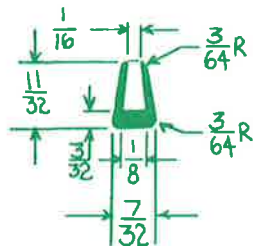

GR 1005

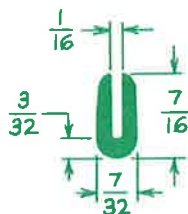

GR 217

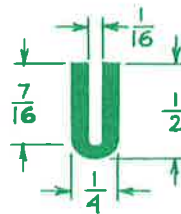

GR 637

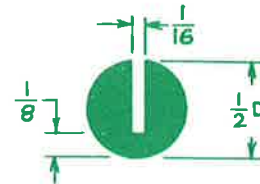

GR 519

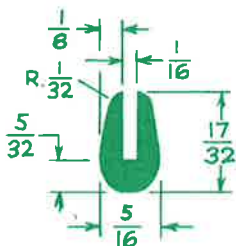

GR 435

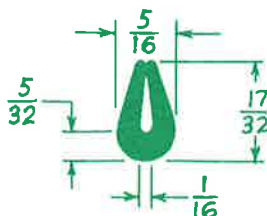

GR 520

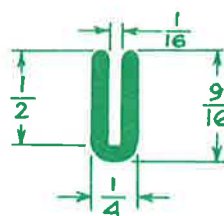

GR 639

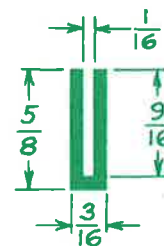

GR 640

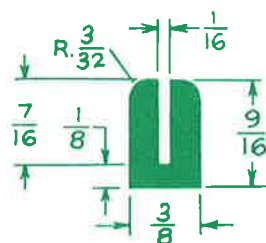

GR 428

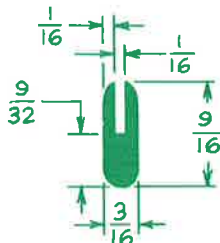

GR 521

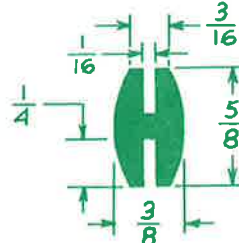

GR 165

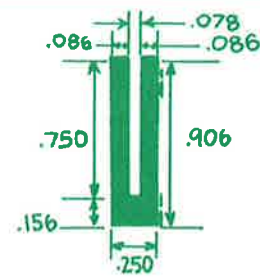

GR 1166

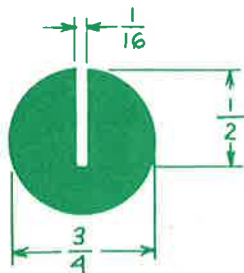

GR 641

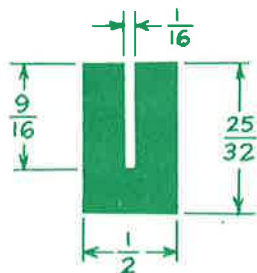

GR 642

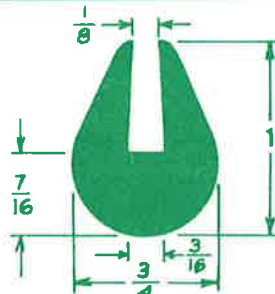

GR 523

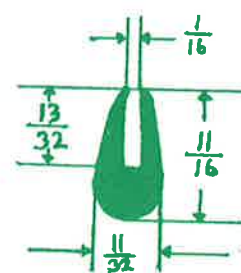

GR 893

Size will vary as color, durometer or compound changes.

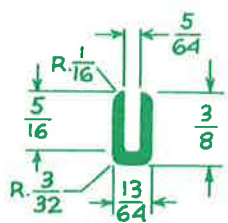

GR 319

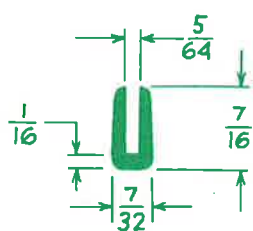

GR 524

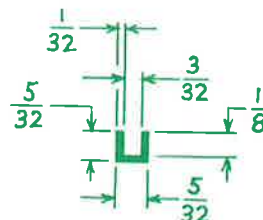

GR 252

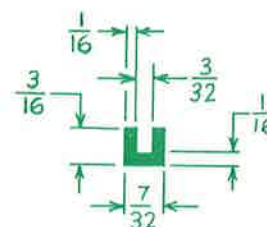

GR 191

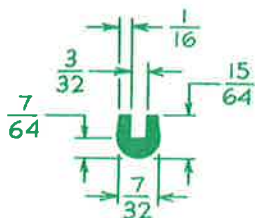

GR 525

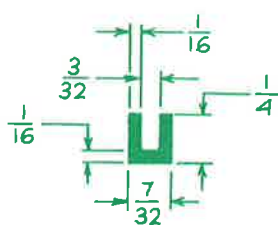

GR 526

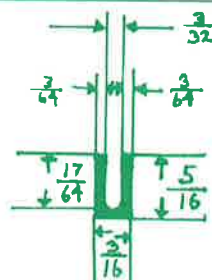

GR 1142

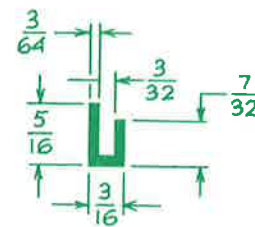

GR 528

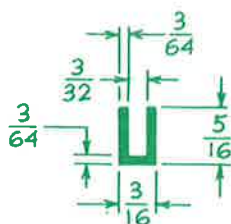

GR 529

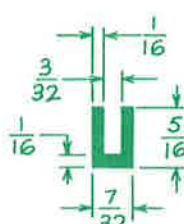

GR 247

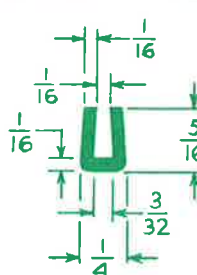

GR 530

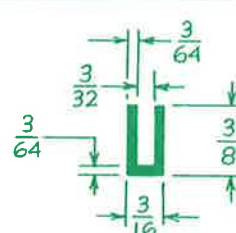

GR 531

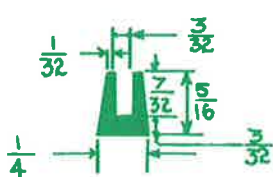

GR 1097

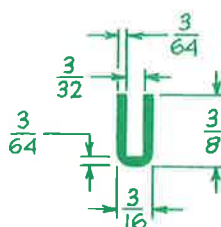

GR 532

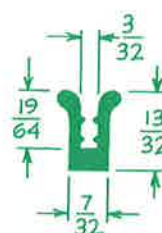

GR 644

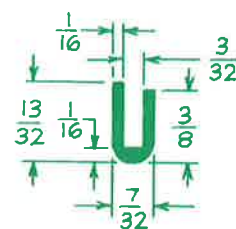

GR 533

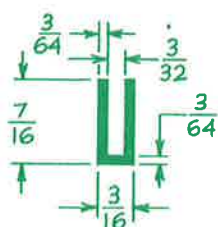

GR 406

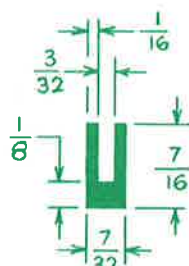

GR 204

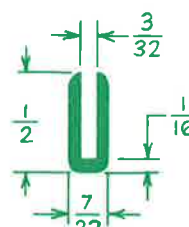

GR 421

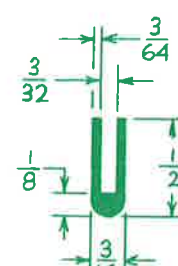

GR 299

Size will vary as color, durometer or compound changes.

U-CHANNELS
3/32 - 1/8

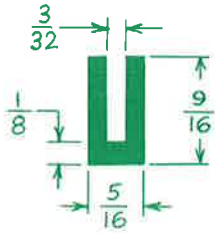

GR 645

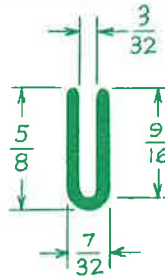

GR 646

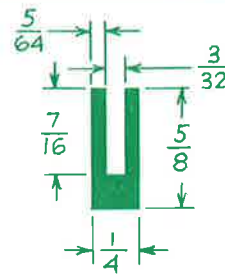

GR 432

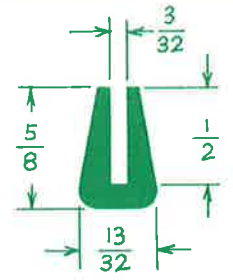

GR 647

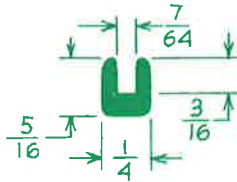

GR 648

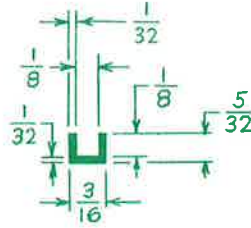

GR 395

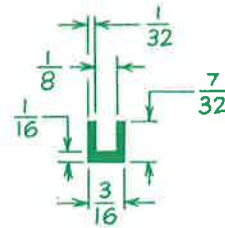

GR 534

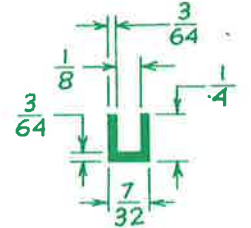

GR 414

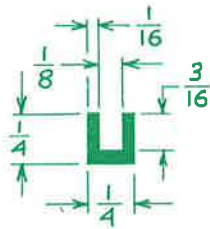

GR 257

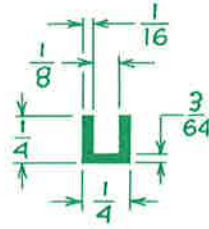

GR 535

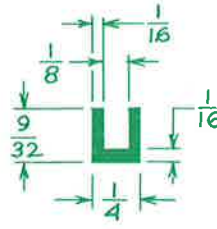

GR 536

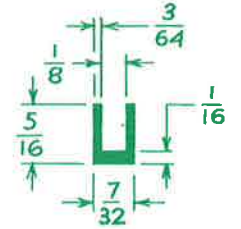

GR 291

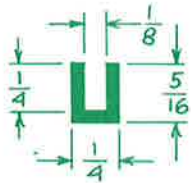

GR 258

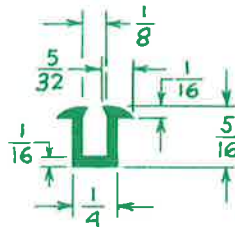

GR 649

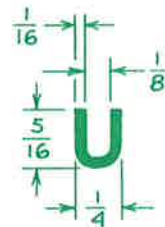

GR 537

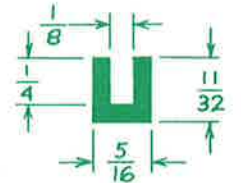

GR 726

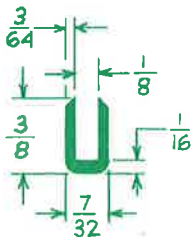

GR 538

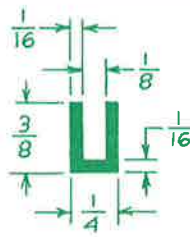

GR 120

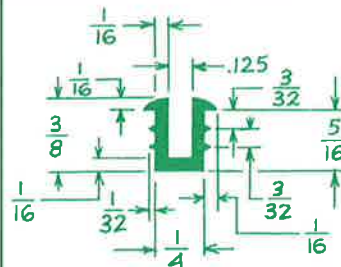

GR 259

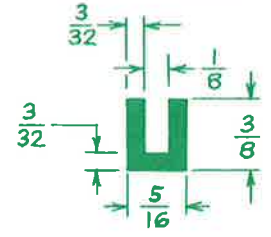

GR 539

Size will vary as color, durometer or compound changes.

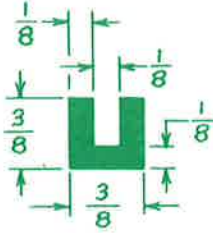
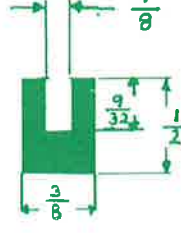
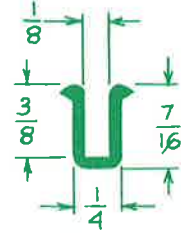
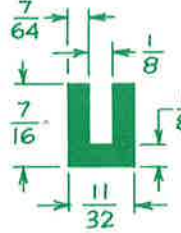
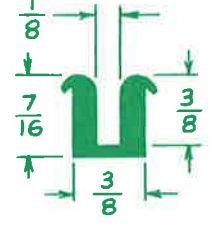
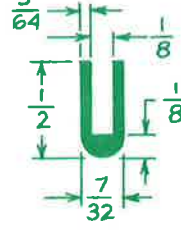
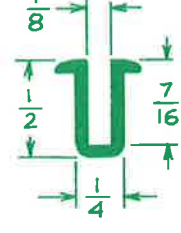
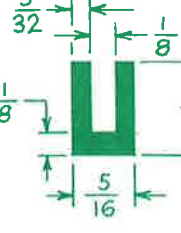
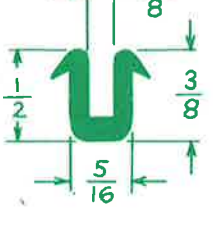
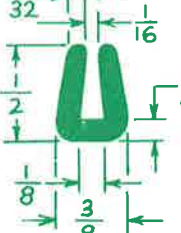
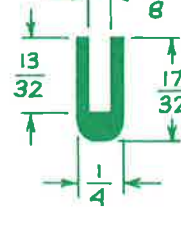
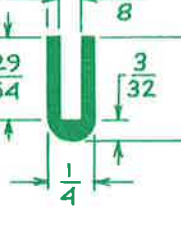
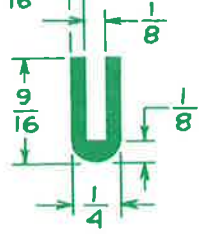
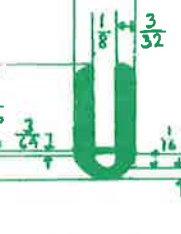
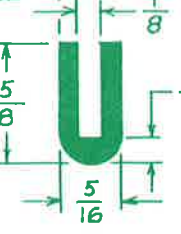
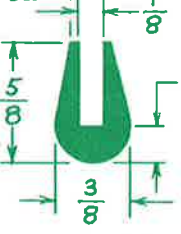
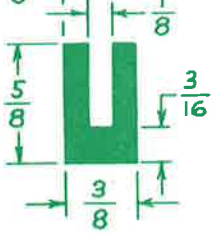
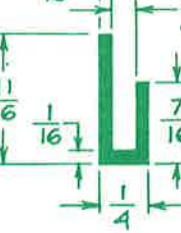
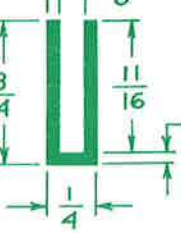
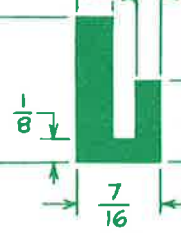
 <p>GR 650</p>	 <p>GR 1082</p>	 <p>GR 651</p>	 <p>GR 475</p>
 <p>GR 652</p>	 <p>GR 541</p>	 <p>GR 653</p>	 <p>GR 542</p>
 <p>GR 654</p>	 <p>GR 543</p>	 <p>GR 655</p>	 <p>GR 472</p>
 <p>GR 544</p>	 <p>GR 1148</p>	 <p>GR 545</p>	 <p>GR 546</p>
 <p>GR 114</p>	 <p>GR 547</p>	 <p>GR 245</p>	 <p>GR 548</p>

Size will vary as color, durometer or compound changes.

U-CHANNELS
1/8 - 3/16

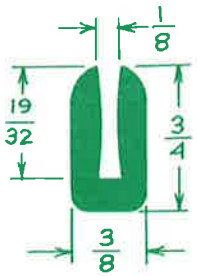

GR 657

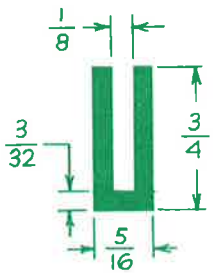

GR 658

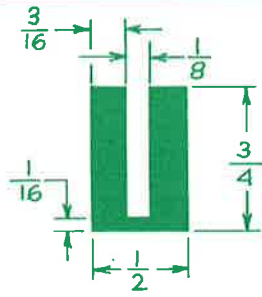

GR 549

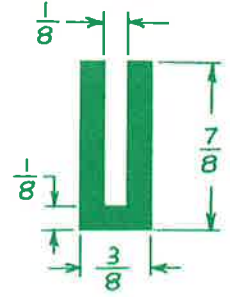

GR 659

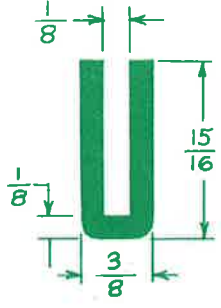

GR 660

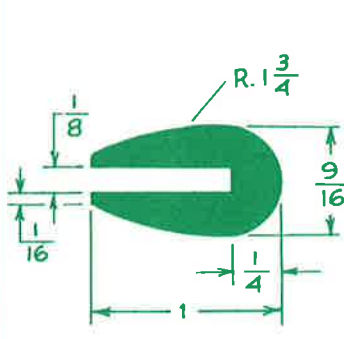

GR 550

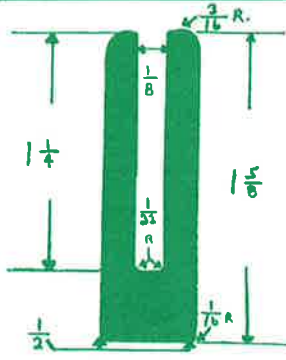

GR 806

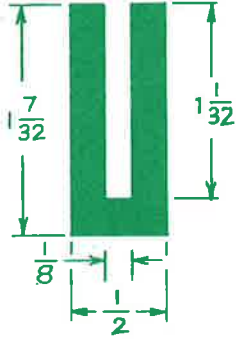

GR 661

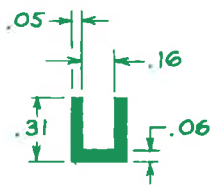

GR 408

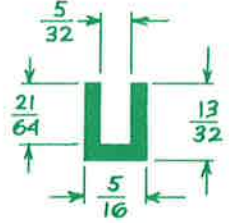

GR 662

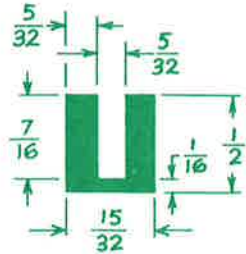

GR 128

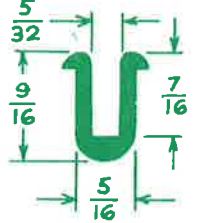

GR 663

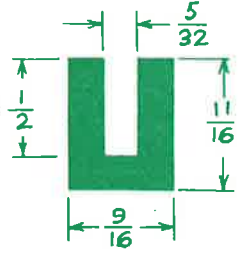

GR 664

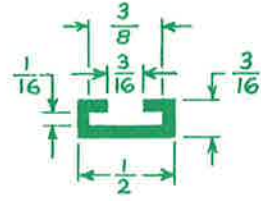

GR 707

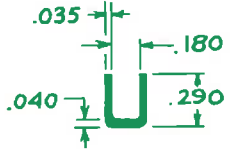

GR 444

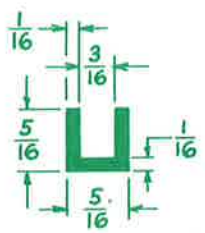

GR 117

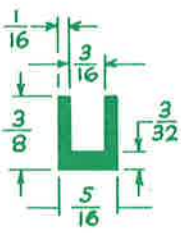

GR 552

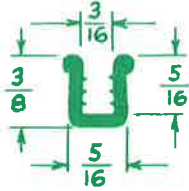

GR 665

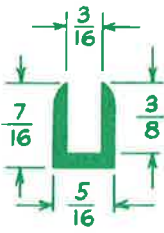

GR 666

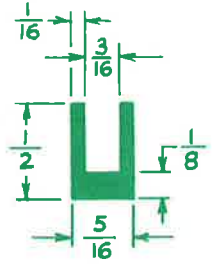

GR 553

Size will vary as color, durometer or compound changes.

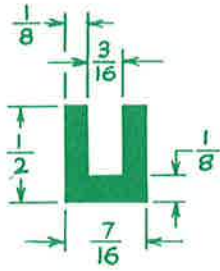

GR 554

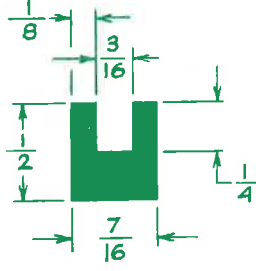

GR 192

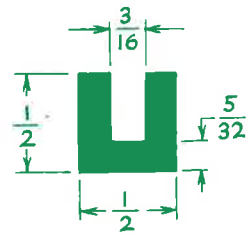

GR 667

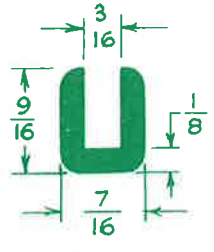

GR 668

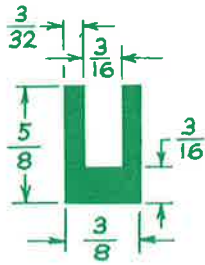

GR 555

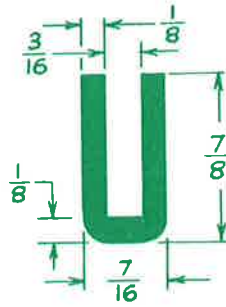

GR 556

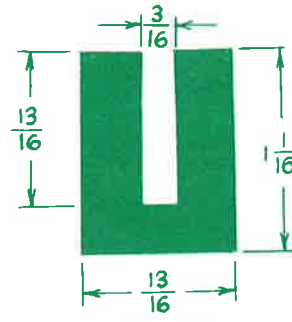

GR 669

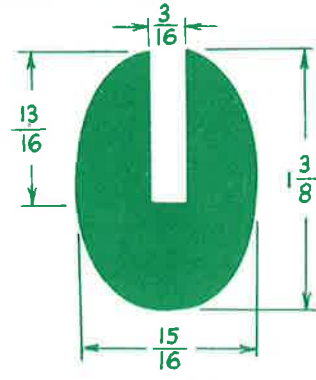

GR 670

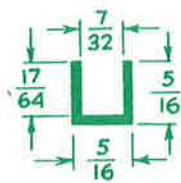

GR 671

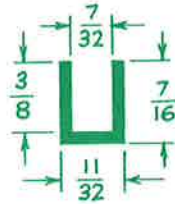

GR 672

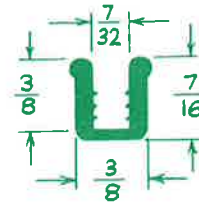

GR 673

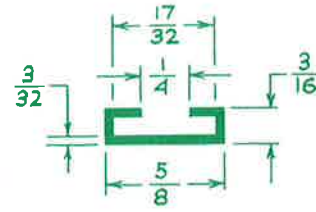

GR 708

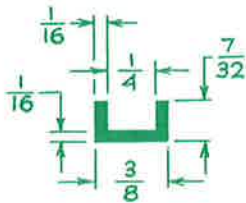

GR 335

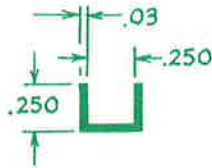

GR 442

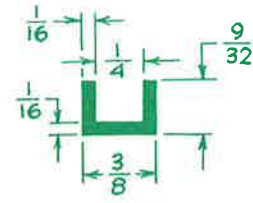

GR 366

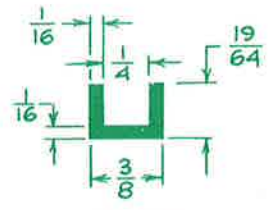

GR 557

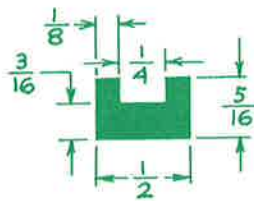

GR 436

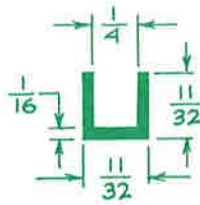

GR 675

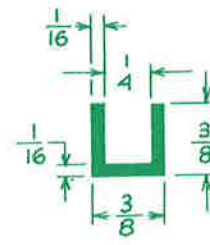

GR 111

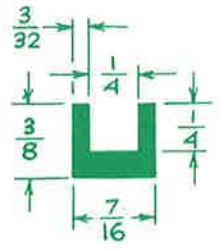

GR 229

Size will vary as color, durometer or compound changes.

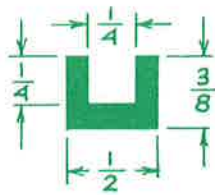

GR 676

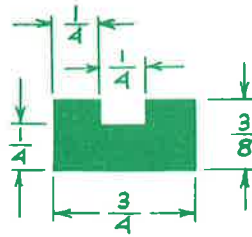

GR 559

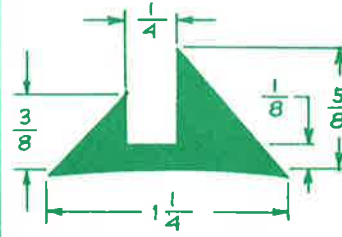

GR 358

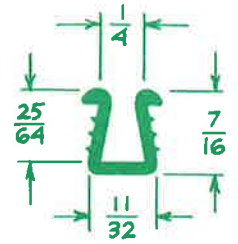

GR 677

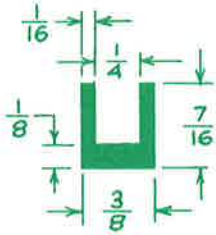

GR 560

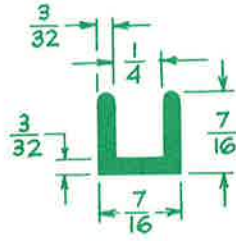

GR 561

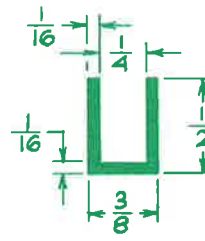

GR 562

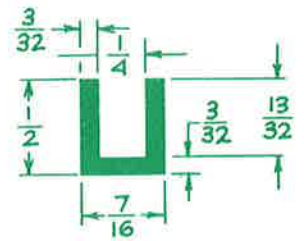

GR 273

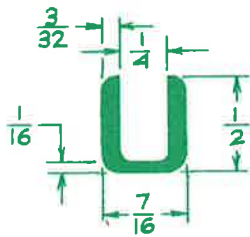

GR 563

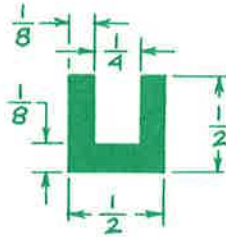

GR 564

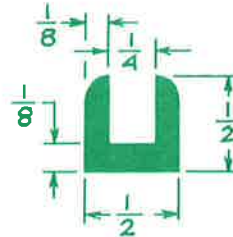

GR 119

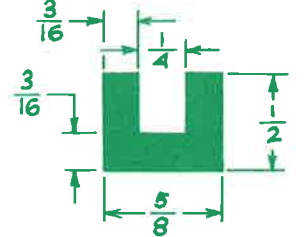

GR 565

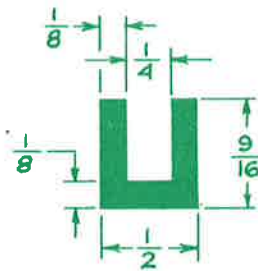

GR 566

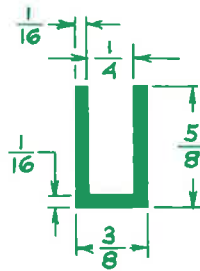

GR 567

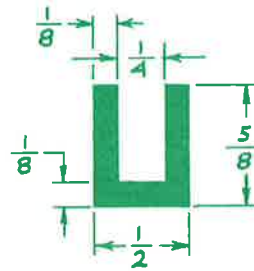

GR 568

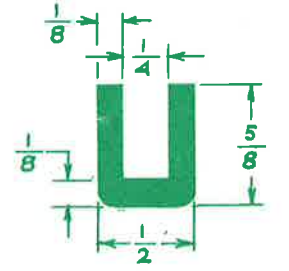

GR 569

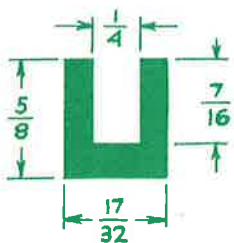

GR 177

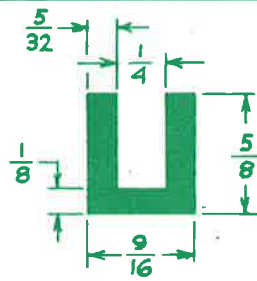

GR 570

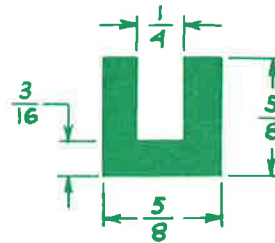

GR 678

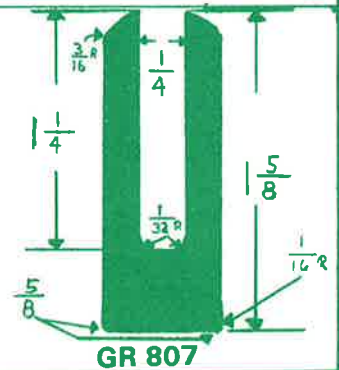

GR 807

Size will vary as color, durometer or compound changes.

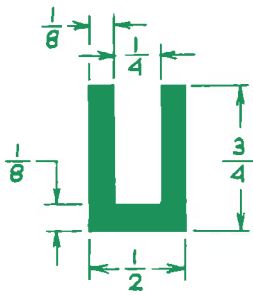

GR 571

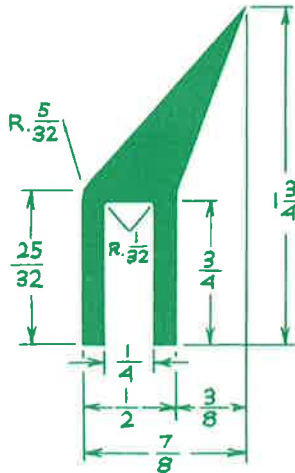

GR 298

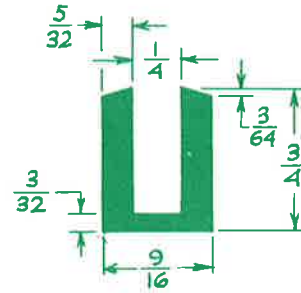

GR 572

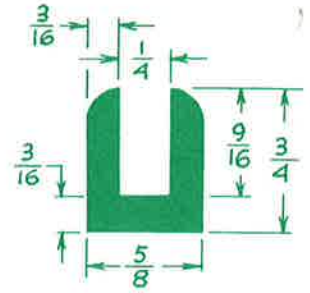

GR 270

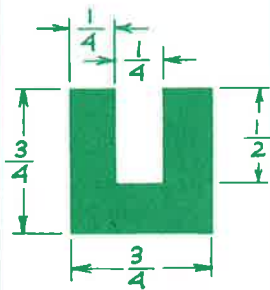

GR 313

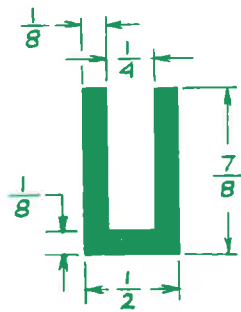

GR 573

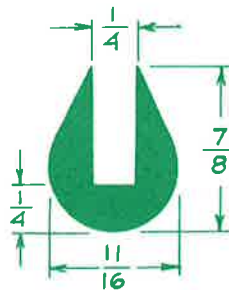

GR 680

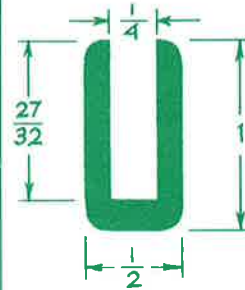

GR 681

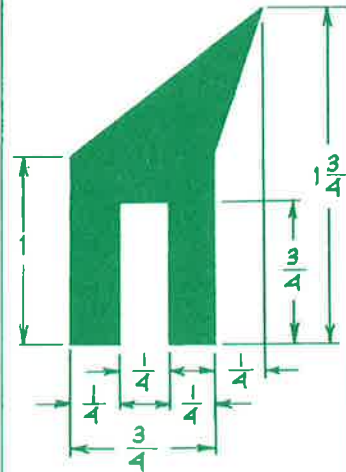

GR 292

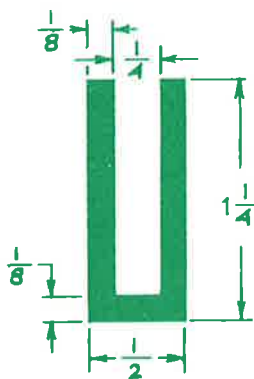

GR 387

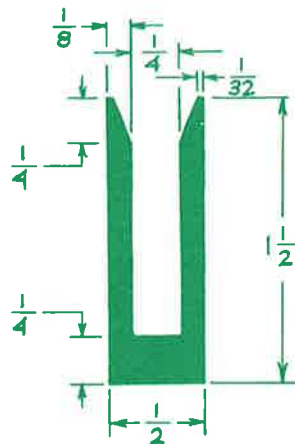

GR 424

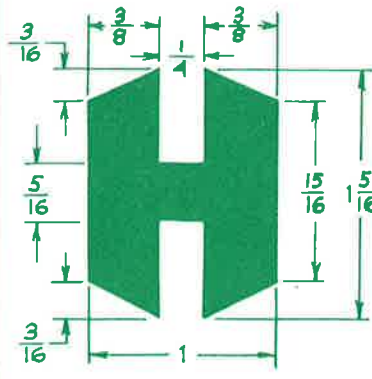

GR 126

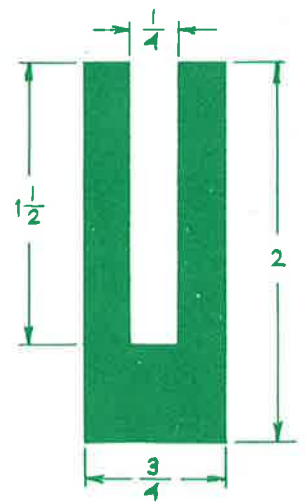

GR 458

Size will vary as color, durometer or compound changes.

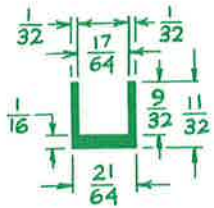

GR 415

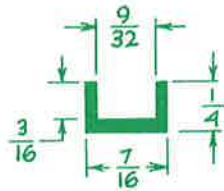

GR 682

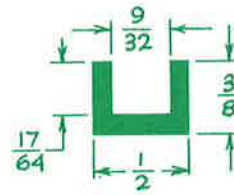

GR 683

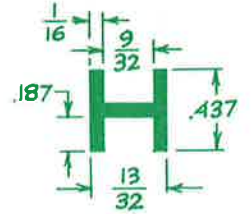

GR 228

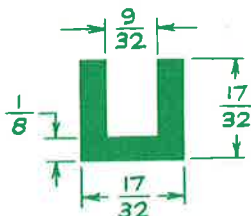

GR 684

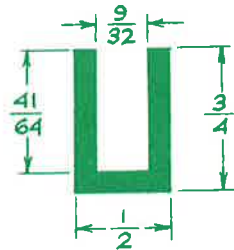

GR 685

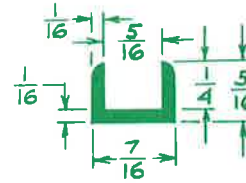

GR 272

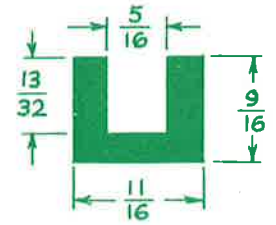

GR 686

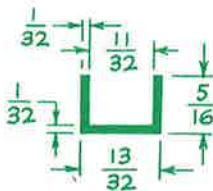

GR 300-1

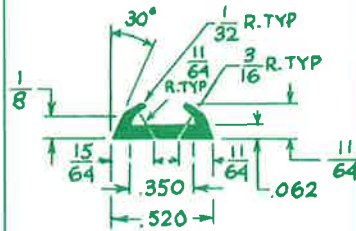

GR 375

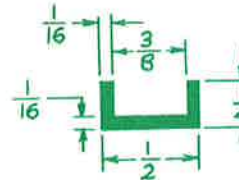

GR 419

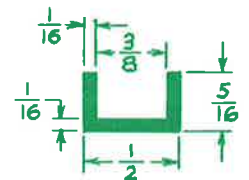

GR 574

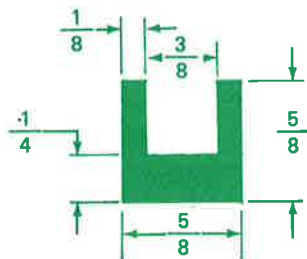

GR 370

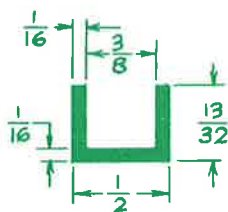

GR 575

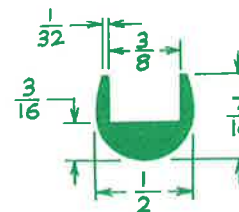

GR 576

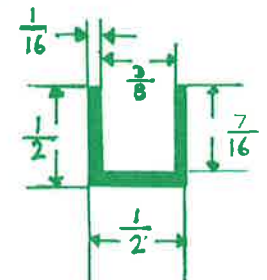

GR 872

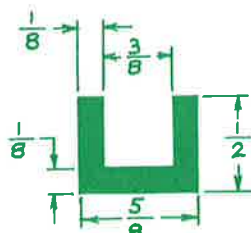

GR 577

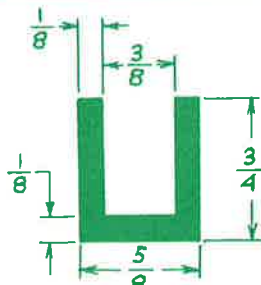

GR 578

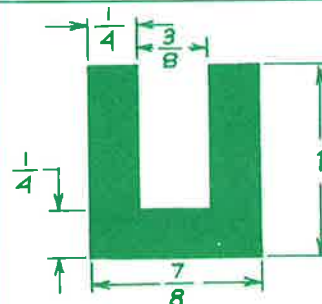

GR 248

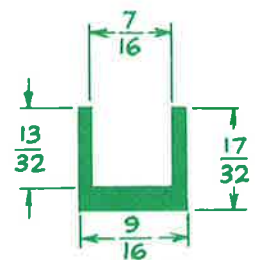

GR 687

Size will vary as color, durometer or compound changes.

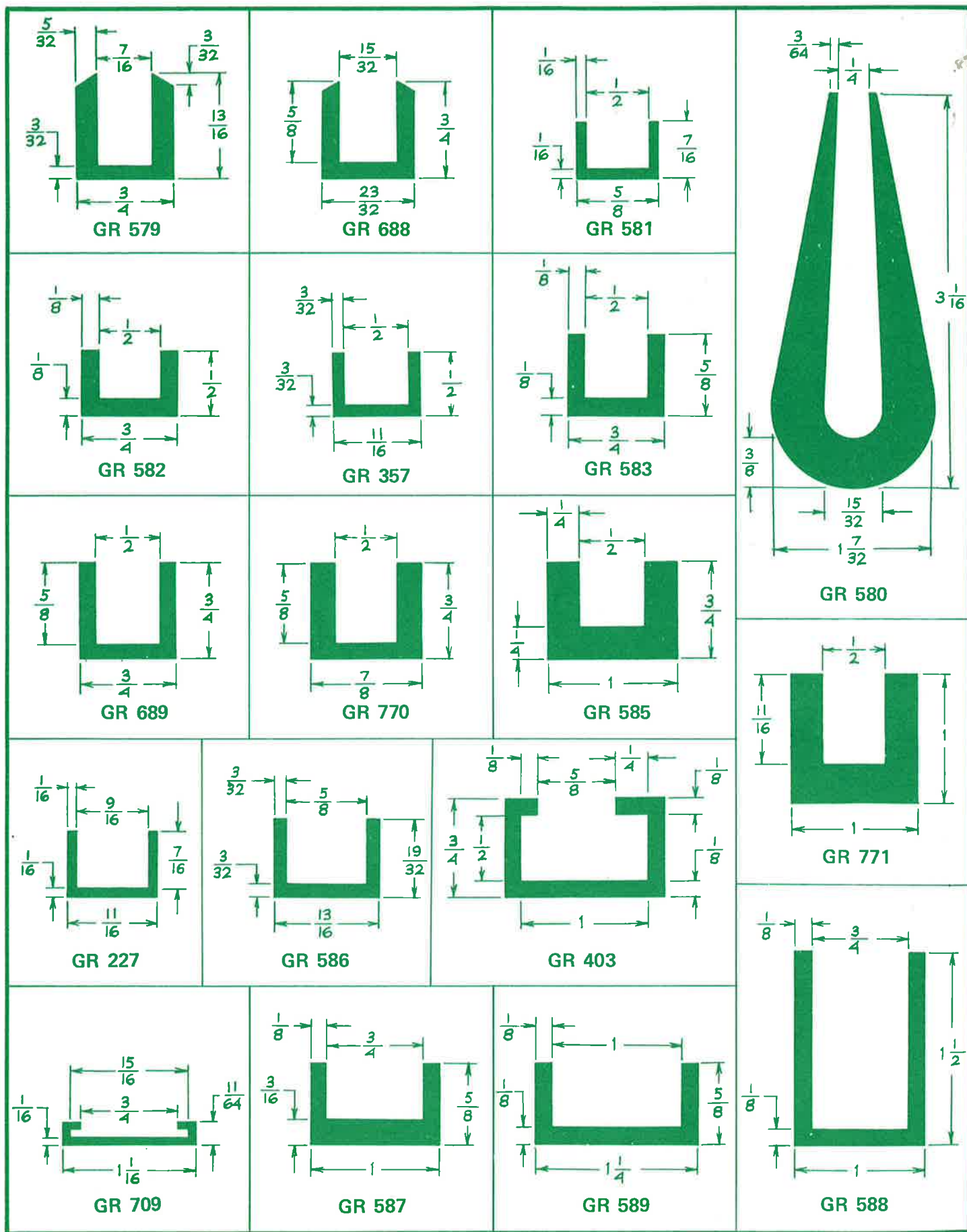

Size will vary as color, durometer or compound changes.

U-CHANNELS
1 - 3-1/4

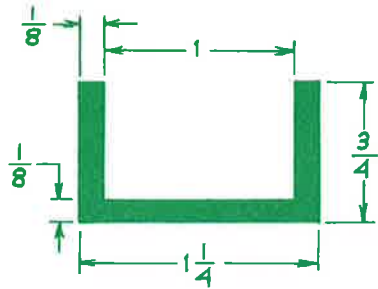

GR 590

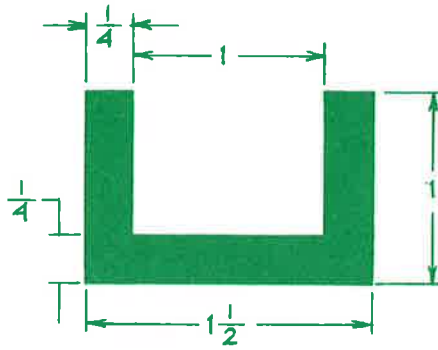

GR 591

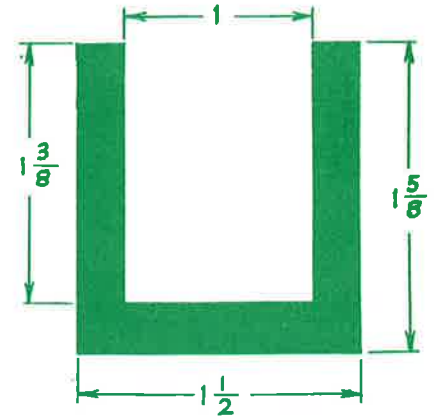

GR 772

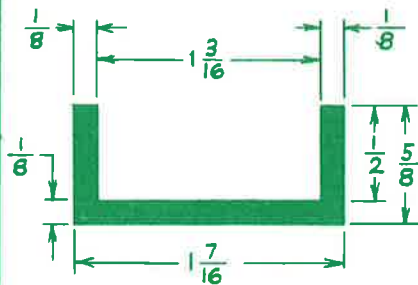

GR 450

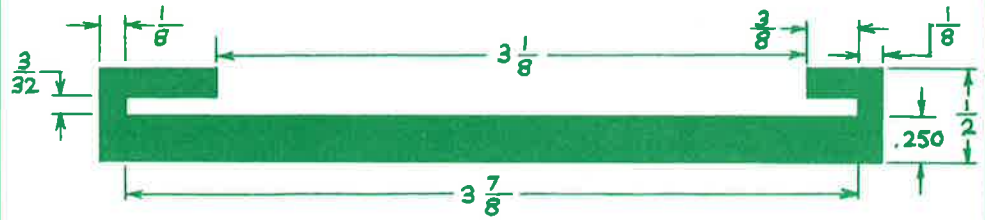

GR 360

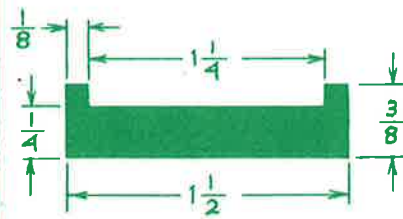

GR 592

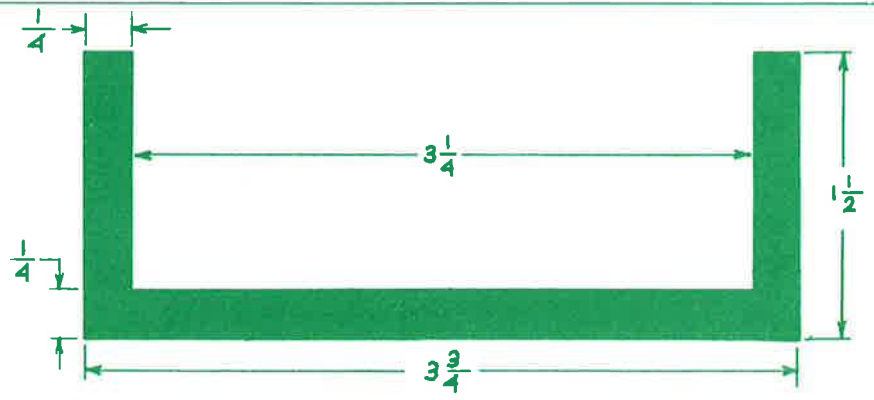

GR 593

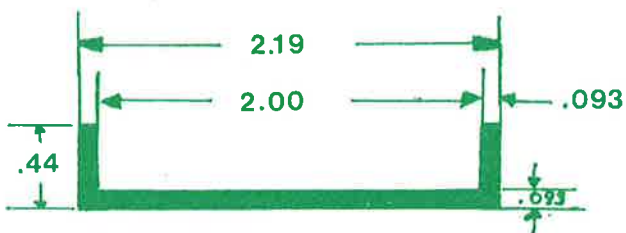

GR 1120

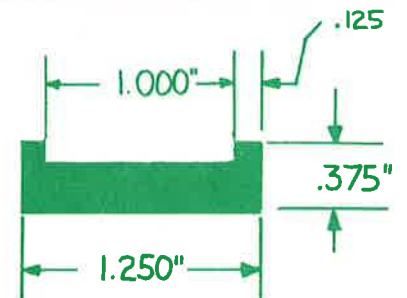

GR 1198

Size will vary as color, durometer or compound changes.